

rotork® Controls

IQ Range



IQ Multi-turn
Electric Valve Actuators

Redefining Flow Control

Contents

rotork® Controls

Section	Page	Section	Page
Section 1		Section 2	
3 rd Generation IQ Actuator	3	Actuator Specification (full contents list on p17)	17
IQ3 Features	4	Performance summaries	18
IQ3 Multi-turn Actuator Range	7	Actuator Drive Couplings	22
Advanced Engineering	8	Standard Specification	23
Design Features –		Valve Type – Actuator	24
Reliability	10	Design Specification	25
Protection	11	Non-Hazardous & Hazardous Enclosures	27
Intelligent Communication	12	Regulatory Standards	29
Application Options	15	Power, Control & Indication	30
Network Systems	16	Protection & Operating Features Components	36 38



Rotork is the global market leader in valve automation and flow control. Our products and services are helping organisations around the world to improve efficiency, assure safety and protect the environment.

We strive always for technical excellence, innovation and the highest quality standards in everything we do. As a result, our people and products remain at the forefront of flow control technology.

Uncompromising reliability is a feature of our entire product range, from our flagship electric actuator range through to our pneumatic, hydraulic and electro-hydraulic actuators, as well as instruments, gear boxes and valve accessories.

Rotork is committed to providing first class support to each client throughout the whole life of their plant, from initial site surveys to installation, maintenance, audits and repair. From our network of national and international offices, our engineers work around the clock to maintain our position of trust.

Rotork. Redefining flow control.

3rd Generation IQ Actuator

For over 50 years Rotork has used innovation in designing reliable, flexible and robust valve actuators and control systems. Continuing our ethos of evolving design, the 3rd generation IQ multi-turn actuator is now available. Reliability standards have been set even higher, it is simpler to commission and use and is unrivalled in its ability to provide valve and process control operational data.



Key benefits of the 3rd generation IQ

- Valve position monitoring during power loss through simple and robust Rotork absolute encoder
- Large information-rich backlit display
- Advanced dual stacked display presents valve and process data for asset management and data analysis
- In the event of power failure actuator display and remote contacts are maintained
- Toughened glass screen plus optional environmental shield
- Outstanding environmental protection
- Non-intrusive setting – no cover removal required using secure *Bluetooth*[®] connection
- Enhanced reliability through solid state controls; reduced internal wiring; simplified torque sensor
- Detachable thrust bases across the entire range
- Advanced realtime status reporting
- Configurable datalogger functionality, including service alarms
- Plug & socket option available



IQ3 Features



Simple, secure commissioning and configuration

Ensuring correct configuration and keeping it secure is the bedrock of reliable operation.

All IQ actuators are set up non-intrusively using a Rotork setting tool. Torque levels, position limits, control and indication functions can all be accessed using the intrinsically safe, wireless handheld setting tool. Compatible with the existing infra-red IQ Setting Tool, 3rd generation IQ can now operate using its partner Rotork *Bluetooth*[®] Setting Tool Pro. *Bluetooth* wireless connectivity allows easier use without direct line-of-sight and over greater distances, however security has to match. This is achieved by the initial 'pairing' of tool and actuator being carried out by a single infra-red transaction after which a *Bluetooth* wireless connection automatically takes over. As before, configuration changes are password protected and the actuator is immune to connection by non-Rotork devices or programmes.

New 3rd generation IQ actuators benefit from further advances in human interface design. In addition to a configurable, information-rich display, they offer a highly intuitive menu system for commissioning, updates and diagnostics.

With the latest version of the Rotork Insight2 software, you can further streamline actuator setup, by pre-defining complete sets of instructions and settings. Each collection of settings can be saved as a 'mission' and quickly applied to individual actuators via the handheld Rotork *Bluetooth*[®] Setting Tool Pro.

IQ actuators can be interrogated and set up even when mains power is not available; the actuator can be configured and interrogated by using power from its display back-up battery.

Product enhancements

- New intuitive user interface
- Advanced dual stacked display with configurable datalogger functionality
- Configurable service alarms
- Toughened glass screen plus optional environmental shield
- Rotork *Bluetooth*[®] Setting Tool Pro with secured *Bluetooth* connection
- High reliability, solid-state controls
- Reduced internal wiring and connections
- Simplified torque sensor
- Simple and robust absolute position sensor with high reliability and accuracy
- New thrust base design separable for all sizes
- Advanced realtime status reporting

IQ3 Features

Outstanding reliability

Valve operation must be reliable. Rotork IQ actuators are designed to meet the toughest applications and engineered for a lifetime of uninterrupted service. Built on the Rotork drive train, proven for over 40 years, 3rd generation IQ actuators feature numerous enhancements including:

- Advanced absolute position measurement
- Simplified control components
- Increased thrust base integrity; separable across all sizes
- High immunity from spurious signals
- Configurable motor drive "enable" input which stops the actuator operating unless a signal is applied
- Casing material selection and coatings have been designed for improved corrosion protection

Reliability of equipment depends on the protection provided by its enclosure. IQ retains the Rotork developed double-sealed, non-breathing, non-intrusive enclosure proven to maximise operational reliability. Regardless of whether the actuator is in a hazardous location or not, the fully sealed enclosure provides the highest reliability.

Asset management

With an advanced dual stacked display, position, torque, status and configuration data is clear and immediate. In addition the valve, actuator and process data is available on screen or in the control room. Valve stroke torque/thrust graphs, duty trend logs, vibration levels and valve & actuator manufacturing data can be extracted by the user and stored as the basis for planned maintenance and operational activities, process performance characteristics and comparison.

Commissioning and configuring 3rd generation IQ actuators is faster and simpler than ever. In addition to a new and intuitive user interface, entire operations can now be carried out in moments and datalogger data downloaded using the supplied Rotork *Bluetooth*® Setting Tool Pro.



Technological Advances

Position

Reliable valve position sensing is critical. Using the latest technology and after years of testing, the patented Rotork IQ absolute encoder is contactless, has only four active parts, can measure up to 8,000 output turns and has redundancy and self checking. Unlike existing absolute encoder designs, this technological breakthrough increases position sensing reliability while providing zero-power position measurement.

Display

The dual stacked display allows large segment character position displays down to -50 °C while the matrix display provides detailed setting, status and diagnostic multilingual screens. Overall the display is 30% bigger, is backlit to provide excellent contrast even in the brightest ambient light conditions and is protected by a toughened glass window. An optional protective clip-in cover is available where high UV levels or abrasive environments are present.

Torque

The 3rd generation of IQ utilises the torque sensor developed and used successfully by Rotork for over 10 years. Torque generated in moving the valve produces a proportional thrust reaction on the motor wormshaft. This thrust creates pressure in the piezo torque transducer which converts it to a voltage signal directly proportional to the output torque being produced by the actuator. This signal is used by the control circuit for torque limiting, realtime torque indication and for recording valve operating force profiles by the datalogger.

Now enhanced to provide increased integrity and performance, torque sensing is simple, accurate with high resolution and extremely reliable over the life of the actuator. Unlike other systems employed, the IQ system of torque measurement has the advantage of being independent of voltage and temperature variations.

Control

Control elements such as main control and network interface cards, like those used with fieldbus systems, are connected using an internal bus system based on CAN, reducing wiring and connections and increasing reliability.

Indication power

With the absolute encoder, a battery is not required for position sensing and tracking. As all configuration and datalogger data is stored in non-volatile EEPROM memory, all settings are safe when no power is available. However, to maintain the display and ensure remote indication is kept updated, allow data logging and power off commissioning, an indication battery is included as standard. Reduced power consumption means the battery has an exceptionally long life and low-cost replacements are available from suppliers globally. In addition, the auxiliary power module option is available, allowing the user to connect a 24 volt supply to the actuator should communication with network systems be required when main actuator power is switched off.

IQ3 Features

Optimised for preventative maintenance

All IQ actuators incorporate a sophisticated datalogger, which can provide comprehensive data capture and analysis for planned maintenance and troubleshooting issues with valves and processes. They capture:

- Valve torque profiles
- Operational starts profiles
- Operational, vibration and temperature trend logs
- Event log

In addition, asset management data regarding the actuator and the valve is stored within the actuator and available for download. Specific asset management information includes:

- Running time
- Average torque
- Starts
- Life statistics

As part of the ongoing commitment to improving asset management and providing reliable data for optimised preventative maintenance, the 3rd generation IQ now includes configurable service / maintenance alarms. The alarm parameters can be set in the assets section of the setup menus and include:

- Open torque levels
- Close torque levels
- Starts/Hr
- Total starts
- Total turns
- Service intervals

With 3rd generation IQ actuators this data can be viewed in realtime using the large dual stacked display. In addition, the data can be downloaded wirelessly with the Rotork *Bluetooth*® Setting Tool Pro or to a PC and analysed using the Rotork Insight2 software.

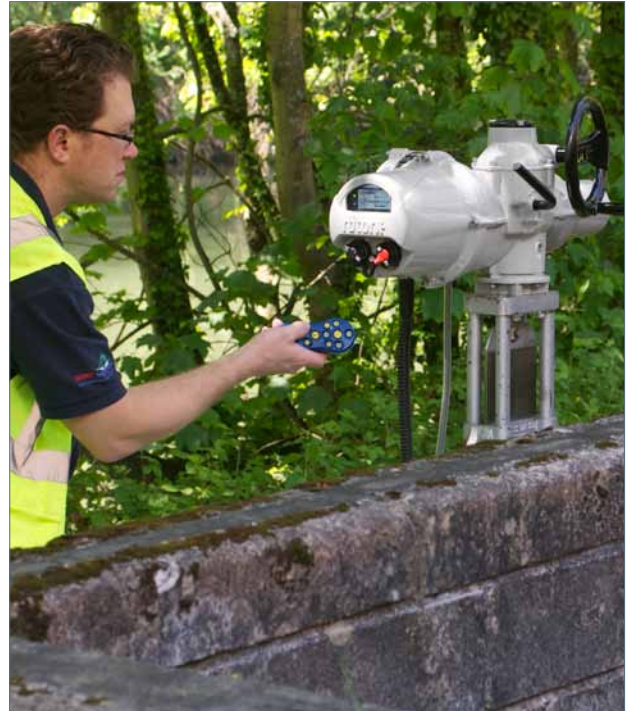

Safe manual operation

In case of an emergency, power outage or failure of the control network, IQ actuators can be operated by hand. A manual clutch and handwheel allow an operator to disengage the motor and operate the valve independently, without risk of damage or injury.

Where the location requires it, the clutch can be padlocked into position to prevent accidental or unauthorised manual operation.

Manual movements of the valve are recorded and logged by the actuator. Position sensing in Rotork IQ actuators is highly reliable (power on or off) thanks to the unique robust and simple design of the absolute encoder.

Network system connectivity

With the addition of an appropriate option card, the IQ actuator can be incorporated into a number of different fieldbus control systems. The IQ actuator can be utilised within the Rotork Pakscan control system, either wired or wirelessly, and the major open Fieldbus protocols including Profibus®, Foundation Fieldbus®, Modbus and HART®.

Future-proofing

3rd generation IQ actuators have been designed with future advances in mind. In addition to highly configurable setup options they now feature flexible design technology.

Using the Rotork Insight2 software and Rotork *Bluetooth*® Setting Tool Pro, it is also possible to apply updates to each actuator. This procedure is subject to four layers of security, with the option of disabling the *Bluetooth* communication for maximum security.

IQ3 Multi-turn Actuator Range



Features across the 3rd generation IQ range include:

- Three-phase, direct current and single-phase variants
- Watertight and hazardous area enclosures
- Double-sealing
- Handwheels for emergency and ease-of-use operation
- Oil bath lubrication
- Advanced, multilingual display for status and setup
- Detailed datalogging
- Setting and data capture using the supplied Rotork *Bluetooth*[®] Setting Tool Pro
- InSight2 PC software for valve performance analysis
- Highly intuitive user interface
- Comprehensive control and flexibility



IQ

IQ multi-turn 3-phase electric actuators designed for isolation or regulation duties (S2 & S3/Class A & B) of up to 60 starts per hour.

Direct torque output range from 34 Nm (25 lbf.ft) to 3,000 Nm (2,200 lbf.ft).

With the addition of second stage gearboxes, multi-turn output torque up to 43,000 Nm (31,715 lbf.ft) and quarter-turn up to 1,000,000 Nm (737,561 lbf.ft) are available.

IQM

The modulating version of the IQ 3-phase electric actuator has a solid state reversing starter in place of the electro-mechanical contactors. They feature fast-response remote control circuits for rapid control. To optimise positional control, the solid state starter also adds an electronic motor 'brake' feature.

The 'hammer-blow' drive - for shifting infrequently used valves - is not included in this model. IQM is suitable for up to 1,200 starts per hour (S4/Class C).

With the addition of second stage gearboxes, IQM multi-turn output seating torque up to 3,600 Nm (2,655 lbf.ft) and quarter-turn up to 58,000 Nm (42,778 lbf.ft) are available.

IQML

Benefiting from all the features of the IQM 3-phase electric actuator, the IQML has a linear output drive providing modulating thrust output of up to 150 kN (33,721 lbf).

IQS

IQS actuators are single phase versions of IQ actuators. Torque range from 65 Nm (48 lbf.ft) to 450 Nm (332 lbf.ft).

With the addition of second stage gearboxes, single-phase multi-turn output torque up to 3,000 Nm (2,212 lbf.ft) and quarter-turn up to 208,500 Nm (153,781 lbf.ft) are available.

IQD

IQD actuators are direct current powered versions of IQ actuators. Torque range 34 Nm (25 lbf.ft) to 305 Nm (225 lbf.ft). Voltage ranges available are 24 VDC, 48 VDC and 110 VDC (limited size/voltage availability – refer to IQD performance data, page 19).

With the addition of second stage gearboxes, DC multi-turn output torque up to 1,500 Nm (1,106 lbf.ft) and quarter-turn up to 132,000 Nm (97,358 lbf.ft) are available.

Special Designs

If you require an IQ actuator for duties that are not covered by our standard range, we are happy to discuss custom solutions.

Advanced Engineering

1 Hand operation

Direct drive and geared handwheel sized for effective manual operation of the valve. Handwheel drive is independent of the motor drive and is selected with a lockable hand/auto lever for safe operation even when the motor is running.

Motor operation always has preference unless the hand/auto lever is purposely locked into 'hand drive'. Lost motion 'hammerblow' action is provided with both direct and geared handwheels.

2 Environmental sealing

The Rotork double-sealed terminal compartment results in the actuator enclosure being completely sealed, protecting the actuator from the environment for life. Using the supplied Rotork *Bluetooth*® Setting Tool Pro, no covers need to be removed for commissioning, adjusting, analysis or accessing the actuator data log.

3 Display

The advanced dual stacked display is significantly larger, clearer and has a wide viewing angle making it easily legible from a distance. In normal mode the LCD display indicates valve position and can operate from -50 °C up to 70 °C.

The matrix layer provides high resolution screens for setting menus, status, alarm and graphical data log screens such as valve torque profiles. Position indication lights (red, yellow and green) are duplicated each side of the display. All display elements are protected by a 13 mm toughened glass window with an optional shield for protection against abrasive media such as sand and UV light.

4 Local controls

Local open/close and lockable Local/Stop/Remote selectors are coupled magnetically to the designated switches and therefore do not penetrate the control cover. This further enhances the non-intrusive protection of the IQ.

5 Position control

The unique Rotork patented absolute position sensor is highly accurate and can measure up to 8,000 output turns as standard. With only four active parts it is very simple and robust, providing the most reliable position sensing regardless of the availability of electrical power. It also includes built-in redundancy and self-checking.

6 Proven drive train

The drive train and motor uses the proven basic design principals employed for over 40 years. Simple, reliable and robust, the components are oil bath lubricated (for life).

7 Separable bases

For all sizes the thrust and non-thrust base types are separate to the gearcase allowing easy installation. Should the actuator be removed, the base can be left on the valve to maintain its position. All bases conform to attachment standards ISO5210 or MSS SP 102.

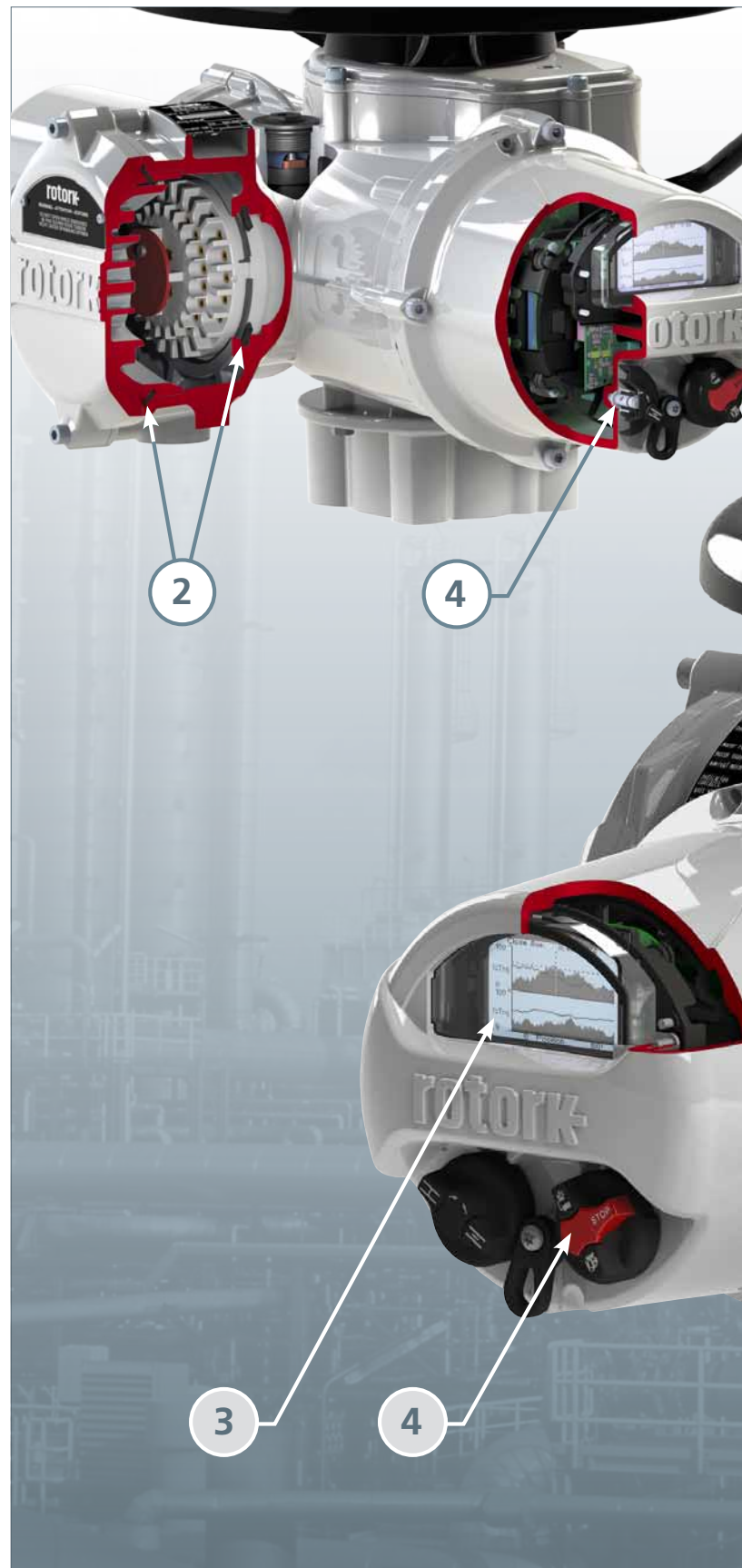

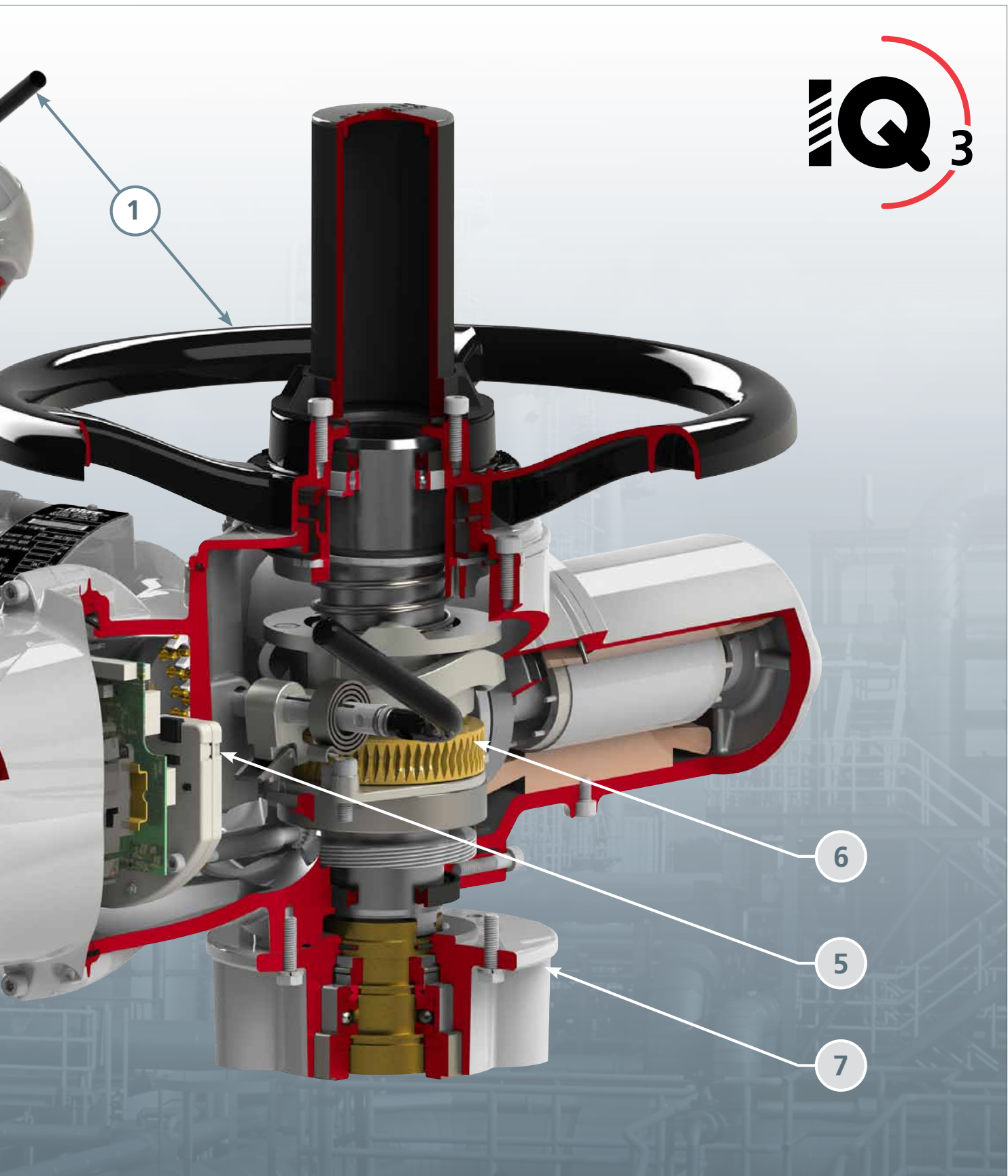

Design Features – Reliability



Synchrophase prevents valve damage caused by incorrect wiring

Rotork's 'Synchrophase' automatic phase rotation correction control prevents valve damage caused by incorrect wiring by ensuring that the IQ three-phase motor is always presented with the correct phase rotation. Synchrophase senses the incoming phase rotation then energises the appropriate contactor to cause movement in the correct direction.

Single phasing protection*

The IQ power module monitors all three phases of the power supply. Should one or more phases be lost the control system inhibits operation, preventing motor 'single phasing' and burn-out. The actuator display will indicate 'phase lost', remote indication is also available from the configurable indication contacts.

Valve jammed protection

The actuator faces its severest operating duty during unseating of the valve, when operating forces are at their highest or where an infrequently operated valve can get stuck. IQ has the intelligence to systematically cope with these demands, ensuring reliable valve operation together with valve and actuator protection.

If valve "sticking" is considered possible, as with a wedge gate type, the torque switches can be by-passed during the a configurable portion of travel away from the valve seated position. This allows "extra" torque up to 1.5 times rated to be applied in unseating the valve. In the majority of cases, applying additional force causes the sticky valve to move and allows operation to continue. After the torque switch bypass set position has been reached, the torque switch returns to the set value for the rest of travel. If this additional torque is still insufficient to cause movement, IQ recognises the valve is jammed and stops operation within seconds preventing further valve damage or motor burn-out.

* IQ 3-phase only.

IQ thermostatic protection

In the event of overheating, two thermostats embedded in the motor windings directly sense the temperature and trip the actuator control circuit.

Auto Self Test and Diagnosis (ASTD)

Vital operational circuits automatically self test to ensure correct operation. In the unlikely event that a fault is diagnosed the information is automatically presented on the display. At the same time, actuator operation can be inhibited to enable on-site investigation.

Instant reversal protection

When an actuator is ordered to reverse direction 'instantaneously' an automatic time-delay circuit avoids the shock loads which may cause unnecessary wear to valve stems and gearboxes. The delay also limits current surges through the contactor.

Vibration measurement

Vibration can severely affect plant equipment's performance and life and its effects are cumulative. Levels of vibration can vary significantly depending on process conditions such as start up and shut down, valve cavitation and at different flow rates making it difficult to capture with mobile measuring devices.

The IQ includes a vibration sensor that measures and captures vibration levels in the range 10 Hz to 1 kHz (RMS average) and peak acceleration (maximum g) in 3 axis (x, y and z). Vibration trend logs can be viewed on the display or downloaded and viewed using Insight2.



Design Features – Protection



Critical protection

Vast experience in the application of electric actuators has enabled Rotork to set the global standard in actuator ingress protection. Actuators have to perform unfailingly in environments ranging from desert to tundra, offshore to underground, where flooding, humidity, extremes of heat and cold, ultra violet and corrosive atmospheres are the norm. Rotork understands that the most important factor in the reliability of an actuator is protection from the environment - in simple terms, the enclosure.

Double-sealed for double protection

The IQ enclosure is rated for immersion to IP68*. It is completely watertight and dust tight and does not “breathe”. The Rotork ‘double-seal’ system ensures protection of internal components, separating them from the cable gland and terminal compartment by a watertight terminal block. Protection is maintained during site installation when terminal covers are removed and is independent of cable gland sealing.

* 7 metres for 72 hours / NEMA Type 4/4X/6 and hose proof IP66
(100L / min 2.5 to 3 metres distance for 3 minutes)

Non-intrusive - sealed for life

IQ covers need not be removed for site commissioning. All settings and adjustments are made using the supplied Rotork setting tool via either infrared or *Bluetooth* wireless communication. After assembly in the controlled environment of our manufacturing facilities, air exchanges are eliminated - all internal components are completely protected for life. Non-intrusive control selectors mean there are no moving shafts penetrating the enclosure.

Reliability through simplicity

The IQ combines simplicity of design while extending specification and performance.

Torque measurement

An actuator’s ability to reliably and accurately determine the force applied in operating a valve is fundamental in providing comprehensive valve and actuator protection. The IQ range uses tried and tested technology, proven in industry. IQ utilises the piezo torque sensor developed by Rotork and used successfully for over 10 years. Now enhanced with on board, miniature amplification it is better protected and reliability is increased. Accurate, repeatable torque measurement is achieved independent of variations in frequency, voltage and temperature.

Position measurement

Reliable valve position sensing is critical. Using the latest technology and after several years of development testing, the patented Rotork IQ absolute encoder is contactless, has only four active parts, can measure up to 8,000 output turns and has redundancy and self checking. Unlike existing absolute encoder designs, this technological breakthrough increases position sensing reliability with no power requirement.

Explosionproof conformity

3rd generation IQ actuators conform to the following international explosionproof standards:

- ATEX II 2GD c
- IECEx
- FM3615
- CSA EP to C22.2 No 30-M

Rotork *Bluetooth*® Setting Tool Pro certification conforms to:

- ATEX II 1G
- FM3610
- Canada CSA - C22.2 No.157-92

For full details of certification conformity for non-hazardous and hazardous areas see section 2, page 27.

Design Features – Intelligent Communication

Lifetime support

With communication featuring *Bluetooth* wireless technology, the onboard datalogger and the new dual stacked display, the IQ offers unrivalled support to provide complete product back up with local analysis and configuration. This is further supported up by the introduction of the new Insight2 programme, which allows the user full access to configuration and data analysis. With Rotork's unrivalled worldwide service, network expert advice is always close to hand.

Remote diagnosis - Bluetooth

The Rotork *Bluetooth*® Setting Tool Pro allows downloading and uploading of data logger and configuration files. The tool is intrinsically safe and can be used in hazardous areas. File transfer and data exchange is made using *Bluetooth* wireless technology between the actuator, the Rotork *Bluetooth*® Setting Tool Pro and a PC.

PC tools - Insight2

Rotork Insight2 facilitates the review, configuration and analysis of setup configuration and datalogger information for Rotork *Bluetooth* enabled actuators. The visually interactive application is intuitive with clear menus making it a simple and fast process.

All Rotork *Bluetooth* enabled actuators include an onboard datalogger. The datalogger captures and stores valve, actuator, control signal operation and status data which can be viewed locally on the display or on a PC using Insight2. Log data is time and date stamped and can be viewed on an event by event basis. Insight2 enables the user to pre-configure actuator missions on a PC, transfer them to a Rotork *Bluetooth*® Setting Tool Pro and transmit them to the actuator on-site. The missions can be dedicated to specific actuators by type or serial number and are password protected for extra security.

Standard missions include: extraction of actuator configuration and datalogger, modification of actuator and option configuration.

Password protection is available on the Insight2 software and actuators to prevent unauthorised or accidental modification of actuator configuration parameters.

Key features

- View and modify actuator specification and configuration on PC
- Valve and actuator starts against position log
- Valve reference profile trend logs
- Valve torque profile, open/closed instantaneous and average torque against valve position
- View and modify option card configuration
- Operation and actuator control status log
- Pre-configure missions on a PC and transfer them to actuators in the field via the Rotork *Bluetooth*® Setting Tool Pro. Insight2 requires a PC with a *Bluetooth* interface running Microsoft™ Windows XP or newer



Design Features – Intelligent Communication

Local diagnostics and setup

The large dual stacked, hi-resolution display, with positional characters that are 25 mm high, is unrivalled in visibility for all lighting and orientation conditions. Consisting of a static, high-contrast positional display and a fully configurable dot-matrix LCD behind, the IQ offers the easiest, user-friendly configuration and data analysis ever seen in the actuation world.

Configurable Home-screens

With a mixture of the static and dot-matrix displays, there are now four configurable home-screens available to the user. The four screens reflect the parameters most commonly required to analyse operation at-a-glance:

- Positional information with status

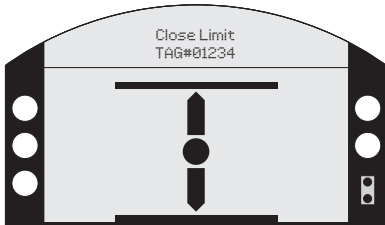

- Positional information with torque (analogue)

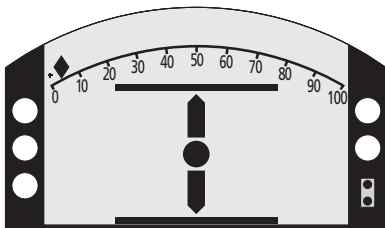

- Positional information with torque (digital)

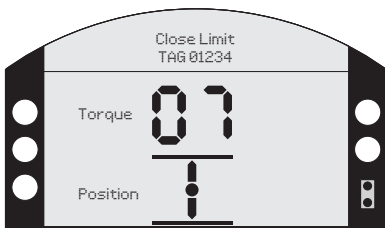

- Positional information with input demand (digital and analogue)

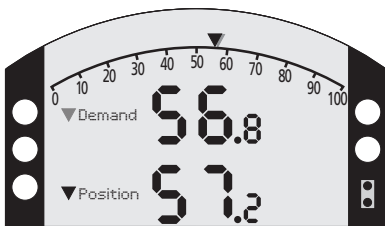

Using the Rotork *Bluetooth*® Setting Tool Pro, each of these screens can be easily accessed with a press of a button. Alternatively you can select one of the four screens to be continually displayed in the setup menu.

User friendly setup menus

A single press of a button on the Rotork *Bluetooth*® Setting Tool Pro takes you into the user-friendly setup menu. This menu has been designed and structured to reduce reliance on having a written manual to hand. With large, clear characters available in many languages, setup and configuration has never been so easy.

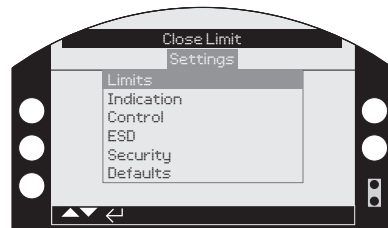
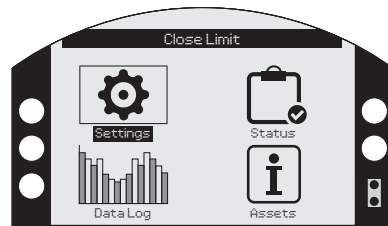

Graphical datalogger

Greater amounts of data and analytical screens are now available in the datalogger and viewable locally. The datalogger screens are displayed on a 168 x 132 pixel dot-matrix display and can display anything from a torque vs position graph to statistical operational data.

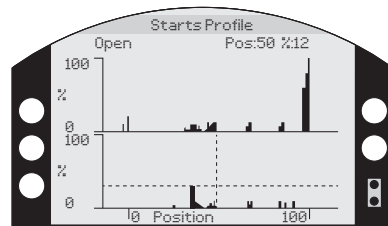
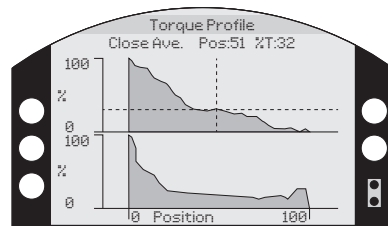

Design Features – Intelligent Communication

Asset management

Not only can you store information relating to the actuator, but also the valve and gearbox. This includes data about build (class, size, ratio and tag numbers) along with service information (commission date, service date etc).

- Actuator data

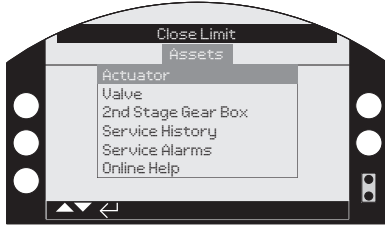

- Valve data

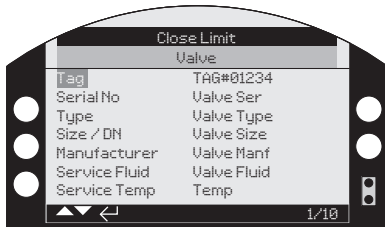

- Gearbox data

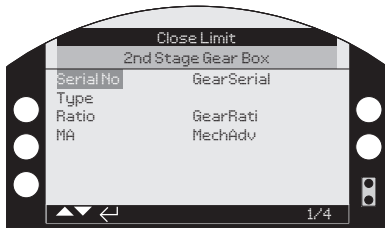

- Service history

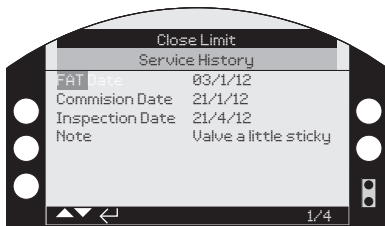

Configurable service alarms

To help optimise preventative maintenance, the 3rd generation IQ now includes configurable service / maintenance alarms. The alarm parameters include:

- Open torque levels
- Close torque levels

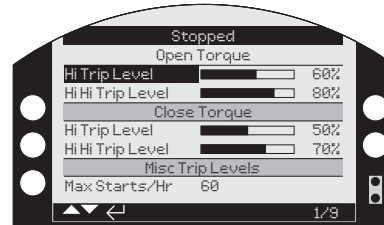

- Miscellaneous trip levels:
 - Starts/Hr
 - Total starts
 - Total turns
 - Service intervals

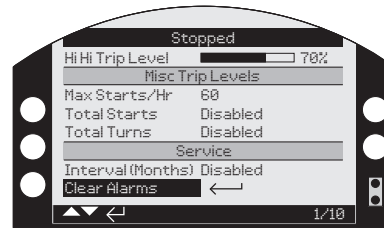

QR Code – 2d barcode

A QR (Quick Response) code or 2d barcode can be generated on the dual stacked display, which can be scanned with a Smartphone. This enables the user a quick link to the Rotork website for further information and online help.



Rotork help – online

Rotork has a comprehensive worldwide service network to provide you with local support wherever you are. Rotork trained technicians working from our network of offices and centres of excellence are available to offer immediate assistance.

To contact Rotork, visit www.rotork.com

Design Features – Application Options

IQ standard specification provides comprehensive control and indication features offering unrivalled flexibility. With second stage multi- and part-turn gearboxes, IQ actuators can meet the highest valve torque and thrust requirements. A sizing programme for both multi- and part-turn valve and damper applications is available at www.rotork.com

In addition, a range of options for use in wide ranging applications are available, some of which are detailed below.

Fireproofing

Meeting the requirements for 30 minutes availability in fire temperatures up to 1,093 °C (2,000 °F) as per fire curve UL1709, bonded intumescent coating allows the display to be visible and actuator covers to be removed while minimising the actuator envelope dimensions. Fire resistant blankets and boxes are also available. For further details refer to publication PUB000-004.



System ER intumescent coating on an IQ actuator.

High temperature service valves – stem expansion

Positive sealing valves, such as solid or flexible wedge gates, may be subject to significant expansion in high service temperatures which may cause damage or leaking valves. The Rotork thrust compensator will remove internal stresses due to thermal expansion and ensure a positive valve seal is maintained on cooling.

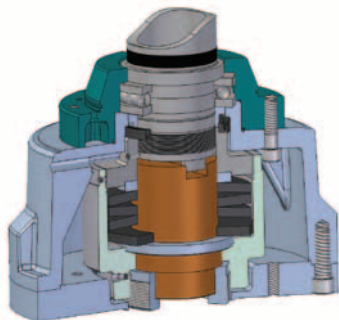

Rotork thrust compensator.

Low temperature

Standard IQ is suitable for use in temperatures ranging between -30 °C and 70 °C (-22 °F and 158 °F). With changes to the build options are available for temperatures down to -50 °C (-58 °F).

Linear output

The Rotork linear drive adaptor converts the rotating torque output of the IQ into a linear thrust output, needed for globe and choke type valves. Both modulating and isolating duty valves can be catered for with the IQML and IQL.

Dampers

Single and multi-vane dampers can be actuated directly or with the addition of a lever arm.

Customising

With over 50 years in the business of valve and flow control, Rotork has the design knowledge, application experience and flexibility to work with customers in providing custom solutions for special applications and conditions. Contact our Sales, Service, Retrofit or Application Engineers to discuss requirements.

Rotork Site Services – RSS

RSS provides specialist service, project and retrofit operations and is an illustration of Rotork innovation in practice. Throughout the company's history, aftermarket services such as retrofit and maintenance have developed to support customers and reinforce Rotork's market leading position. As a result, in some countries Rotork is now the number one service supplier for valve actuation.



Network Systems

Modern facilities require up-to-date communications right down to plant level. Plant managers demand more information quicker than ever before. Process operators need full control facilities at all times of the day and night. Maintenance managers want information so that their services can be scheduled economically.

To meet these requirements, design engineers include field communications networks to allow every piece of critical plant to be controlled and monitored by computer. These computers are assigned to management operations and maintenance tasks within their own network, exchanging data about the equipment and processes under their control.

Integration of the plant controls by use of network connectivity has been a hallmark of Rotork actuator products

for many years. The use of network bus systems makes commissioning of the plant and the subsequent control and monitoring a simple, quick and reliable task.

Rotork actuators are compatible with a wide range of communication and process control systems by including the appropriate network option card during manufacture.

Our own Pakscan system offers advanced actuator network control (wired and wirelessly) similar to network control from Profibus®, Foundation Fieldbus®, Modbus and HART® open systems. Innovative technology together with expert bus system knowledge ensures that Rotork can always provide the ideal solution for the control system.

Refer to Publication PUB058-001 Rotork Network Compatibility for more information and links to other network documentation.

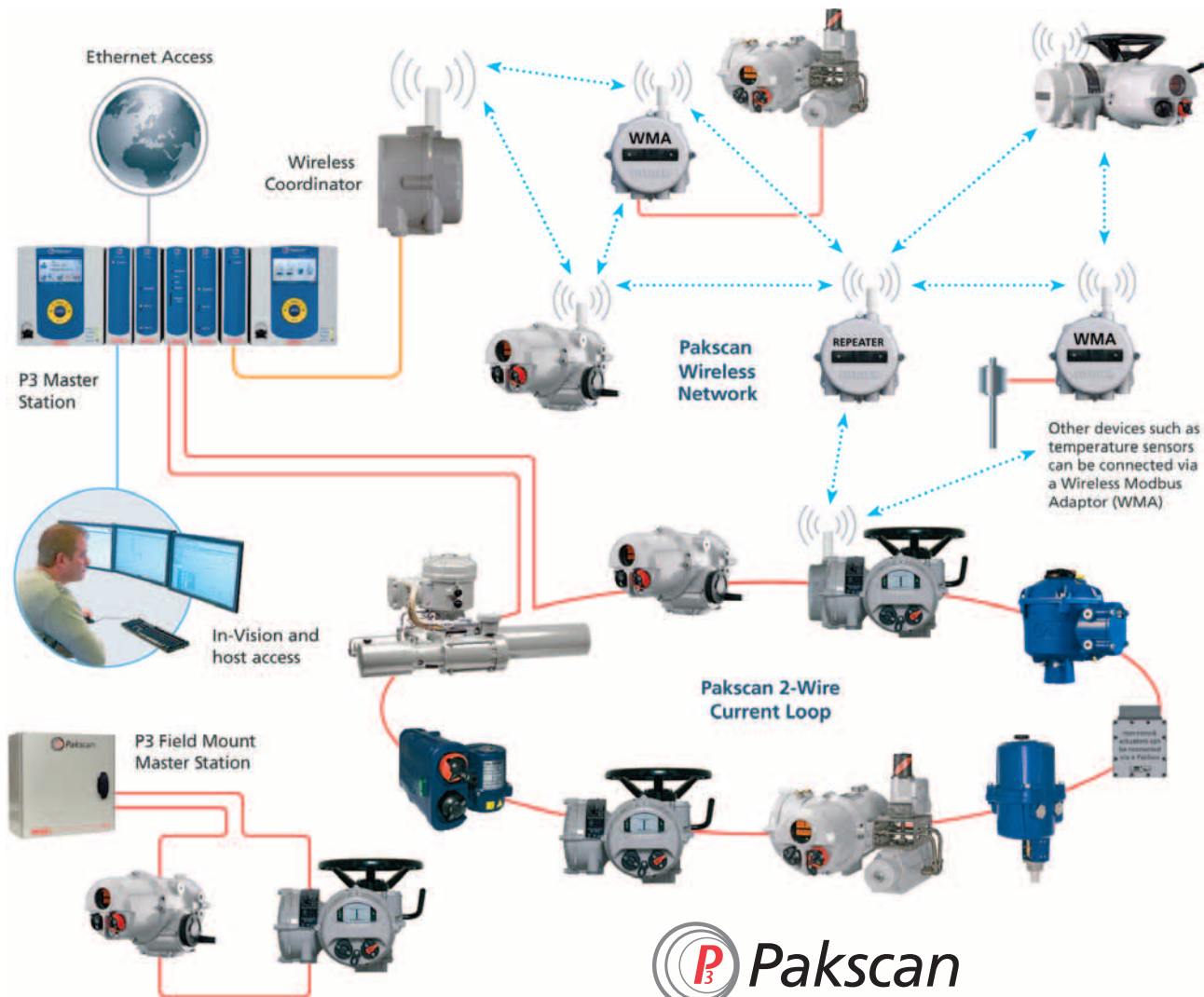

Pakscan Wired and Wireless Network

Actuator Specification

The following pages contain details on performance and specification for the Rotork IQ range of actuators.

Please use the following contents table to help access the information you require.



Section	Title	Page
1	Performance Summaries	18
2	Actuator Drive Couplings	22
Standard Specification		
3	Introduction	23
4	Valve Type – Actuator Selection Guideline	24
5	Design Specification	25
5.1	Duty Rating	25
5.2	Design Life	25
5.3	Vibration, Shock and Noise	26
5.4	Valve / Actuator Interface	26
5.5	Operating Temperature	27
6	Non-Hazardous & Hazardous Certified Enclosures	27
6.1	Non-Hazardous Area Enclosures	27
6.2	Hazardous Area Enclosures	28
7	Regulatory Standards	29
8	Power, Control & Indication	30
8.1	Power Supplies	30
8.2	Local Control, Indication & Set-up	31
8.3	Remote Control & Indication	33
8.4	Fieldbus System Control Options	35
9	Protection & Operating Features	36
10	Components	38
10.1	Handwheel	38
10.2	Lubrication	39
10.3	Finish	39
10.4	Motor	40
10.5	Power Module	41
10.6	Torque Sensor	41
10.7	Position Sensor	41
10.8	Control Module	42
10.9	Conduit / Cable Entries	43
10.10	Terminals	43
10.11	Wiring	43
10.12	Battery	43

IQ 3-Phase Performance Summary

1 Performance Summaries

	Actuator output speeds							
rpm at 50 Hz	18	24	36	48	72	96	144	192
rpm at 60 Hz	21	29	43	57	86	115	173	230

Actuator size	Torque ²							
	Nm	lbf.ft						
IQ10	34	34	34	34	34	34		
	25	25	25	25	25	25		
IQ12	81	81	81	68	48	41		
	60	60	60	50	35	30		
IQ18	108	108						
	80	80						
IQ20	203	203	203	203	176	142	102 ¹	
	150	150	150	150	130	105	75 ¹	
IQ25	400	400	298	244	244	230	149 ¹	
	295	295	220	180	180	170	110 ¹	
IQ35	610	610	542	474	474	366	257 ¹	
	450	450	400	350	350	270	190 ¹	
IQ40	1,020	1,020	845	680	680	542	406 ¹	
	750	750	625	500	500	400	300 ¹	
IQ70	1,490	1,490	1,290	1,020	1,020	745	645 ¹	542 ¹
	1,100	1,100	950	750	750	550	475 ¹	400 ¹
IQ90	2,030	2,030	1,700	1,355	1,355	1,020	865 ¹	730 ¹
	1,500	1,500	1,250	1,000	1,000	750	640 ¹	540 ¹
IQ91							1,355 ¹	1,355 ¹
							1,000 ¹	1,000 ¹
IQ95		3,000						
		2,200						

Notes:

- Due to the effects of inertia and drive nut wear, speeds not recommended for direct mounted gate valve applications.
 - Torque rating is maximum torque setting in both directions. Stall torque will be 1.4 to 2.0 times this value depending on speed and voltage.
- If maximum torque is required for more than 20% of valve travel, refer to Rotork.

IQ Single-Phase and IQ DC

IQ Single-Phase - Performance Data

rpm at 50 Hz rpm at 60 Hz	Actuator output speeds						
	18	24	36	48	72	96	144
	21	29	43	57	86	115	173
Actuator size	Torque ²	Nm	lbf.ft				
IQS12	65	60	45	40	30	25	
	48	44	33	30	22	18	
IQS20	165	130	130	125	100	80	60 ¹
	122	96	96	92	74	59	44 ¹
IQS35 ³	450	400	350	320	230	190	135 ¹
	332	295	258	236	170	140	100 ¹

IQ DC - Performance Data

rpm	Actuator output speeds				
	18	24	36	48	
Actuator size	Torque ²	Nm	lbf.ft		
IQD10	34	34	31	27	
	25	25	23	20	
IQD12	68	68	61	54	
	50	50	45	40	
IQD18		108			
		80			
IQD20	163	163	136	108	
	120	120	100	80	
IQD25	305	305	257	203	
	225	225	190	150	

DC supply voltage

	24 V	48 V	110 V
IQD10	✓	✓	✓
IQD12	X	✓	✓
IQD18	X	✓	✓
IQD20	X	X	✓
IQD25	X	X	✓

Notes:

- 1 Actuator output speed 144/173 rpm is not recommended for direct mounted gate valve applications.
- 2 Torque rating is maximum torque setting in both directions. Stall torque will be 1.4 to 2.0 times this value depending on speed and voltage.
- 3 IQS35 not available at 115 volts.

If maximum torque is required for more than 20% of valve travel, refer to Rotork.

IQ Performance Summary

Mechanical Data

Actuator size	10	20	35	40	(40) ¹	91	95
IQ, IQS, IQD, IQM	12	25		70	(70) ¹		
	18			(90) ¹	90		

Flange size	ISO5210	F10	F14	F16	F25	F30	F25	F30
	MSS SP-102	FA10	FA14	FA16	FA25	FA30	FA25	FA30

Approximate weight ²	Kg	31	54	75	145	160	150	160
	lbs	68	119	165	320	353	331	353

Group "A" Couplings – Torque and Thrust

Thrust rating	kN	44	100	150	220	445	N/A	445
	lbf	10,000	22,480	33,750	50,000	100,000	N/A	100,000

Aluminium Bronze drive couplings supplied pilot bored for machining - Maximum stem acceptance diameter:

A (Z3) ³ Rising	mm	32	51	67	73	83	N/A	83
	ins	1¼	2	2 ⁵ / ₈	2 ⁷ / ₈	3¼	N/A	3¼

A (Z3) ³ Non-Rising	mm	26	38	51	57	73	N/A	73
	ins	1	1½	2	2¼	2 ⁷ / ₈	N/A	2 ⁷ / ₈

Pilot Bore ⁴	mm	15	20	25	33	38	N/A	38
-------------------------	----	----	----	----	----	----	-----	----

Group "B" Couplings – Non-Thrust

Steel drive couplings - Maximum stem acceptance diameter:

B1 Fixed Bore	mm	42	60	80	100	120	100	N/A
---------------	----	----	----	----	-----	-----	-----	-----

B3 Fixed Bore	mm	20	30	40	50	50	50	N/A
---------------	----	----	----	----	----	----	----	-----

B4 (max)	mm	20	32	44	60	60	60	N/A
	ins	¾	1¼	1¾	2¼	2¼	2¼	N/A

Handwheels: IQ, IQS, IQD, IQM, IQML, IQL

Actuator size	10, 12, 18	20	25	35	40	70, 90, 91	95
---------------	------------	----	----	----	----	------------	----

Standard ratio	1:1	1:1	13.3:1	22.25:1	15:1	30:1	45:1
----------------	-----	-----	--------	---------	------	------	------

Option ratio	5:1	13.3:1	1:1 ⁵	N/A	30:1	45:1	30:1 ⁵
--------------	-----	--------	------------------	-----	------	------	-------------------

Notes:

- 1 IQ40 and IQ70 have a F25 base fitted as standard. If specified a F30 or FA30 can be fitted as an option. IQ90 B3 and B4 couplings are supplied with an F25/FA25 base only.
- 2 Approximate net weights of standard build actuators. Actual weight will be dependent on specification and options fitted.
- 3 Rotork standard "Z3" option is extended below baseline allowing additional reach. Refer to page 22.
- 4 Solid coupling option available on request.
- 5 Rimpull does not meet the requirements of EN12570. May be used for lower torque applications or where higher handwheel forces are acceptable.

IQM and IQML Performance Summary

IQM Performance Data

		Actuator output speeds											
		rpm at 50 Hz		18		24		36		48		72	
		rpm at 60 Hz		21		29		43		57		86	
Actuator size		Torque		Nm		lbf.ft							
IQM10	Modulating	17	12.5	17	12.5	15.6	11.5	13.6	10	-	-	-	-
	Seat	34	25	34	25	30	23	27	20	-	-	-	-
IQM12	Modulating	34	25	34	25	30	22	27	20	-	-	-	-
	Seat	61	45	54	40	54	40	48	35	-	-	-	-
IQM20	Modulating	81	60	81	60	68	50	54	40	47	35	-	-
	Seat	122	90	109	80	81	60	68	50	54	40	-	-
IQM25	Modulating	152	112.5	152	112.5	129	95	102	75	102	75	-	-
	Seat	204	150	204	150	163	120	136	100	136	100	-	-
IQM35	Modulating	271	200	271	200	253	187	203	150	203	150	-	-
	Seat	544	400	544	400	408	300	313	230	218	160	-	-

IQML Performance Data

		Actuator output speeds												
		rpm at 50 Hz		18		24		36		48		72		
		rpm at 60 Hz		21		29		43		57		86		
Actuator size	Leadscrew dia/lead mm	Linear Speed at		50 Hz		60 Hz		Thrust		kN		lbf		
IQML10	25 / 3	mm/sec	0.9	1.1	1.2	1.5	1.8	2.2	2.4	2.9	-	-	-	-
		Modulating	7.9	1,785	7.9	1,785	7.3	1,643	6.4	1,429	-	-	-	-
		Seat	15.9	3,570	15.9	3,570	14.6	3,285	12.7	2,858	-	-	-	-
IQML12	25 / 3	mm/sec	0.9	1.1	1.2	1.5	1.8	2.2	2.4	2.9	-	-	-	-
		Modulating	15.9	3,571	15.9	3,571	14.0	3,143	12.7	2,857	-	-	-	-
		Seat	28.6	6,428	25.4	5,714	25.4	5,714	22.3	5,005	-	-	-	-
IQML20	38 / 7	mm/sec	2.1	2.5	2.8	3.4	4.2	5.0	5.6	6.7	8.4	10.0	-	-
		Modulating	22.8	5,128	22.8	5,128	19.0	4,274	15.2	3,419	13.3	2,991	-	-
		Seat	34.2	7,692	30.4	6,838	22.8	5,128	19.0	4,274	15.2	3,419	-	-
IQML20	38 / 15	mm/sec	4.5	5.4	6.0	7.3	9.0	10.8	12.0	14.3	18.0	21.5	-	-
		Modulating	17.6	3,947	17.6	3,947	14.6	3,289	11.7	2,632	10.2	2,303	-	-
		Seat	26.2	5,921	23.4	5,263	17.6	3,947	14.6	3,289	11.7	2,632	-	-
IQML25	38 / 7	mm/sec	2.1	2.5	2.8	3.4	4.2	5.0	5.6	6.7	8.4	10.0	-	-
		Modulating	42.8	9,615	42.8	9,615	36.1	8,120	28.5	6,410	28.5	6,410	-	-
		Seat	57.0	12,821	57.0	12,821	45.6	10,256	38.0	8,547	38.0	8,547	-	-
IQML25	38 / 15	mm/sec	4.5	5.4	6.0	7.3	9.0	10.8	12.0	14.3	18.0	21.5	-	-
		Modulating	32.9	7,401	32.9	7,401	27.8	6,250	21.9	4,934	21.9	4,934	-	-
		Seat	43.9	9,868	43.9	9,868	35.1	7,895	29.3	6,579	29.3	6,579	-	-

IQML size 10 and 12 have base size F10 and stroke length 115 mm / 4 1/2 inches.

IQML size 20 and 25 have base size F14 and stroke length 110 mm / 4 1/3 inches.

Actuator Drive Couplings

2 Actuator Drive Couplings

The IQ range features a removable base and coupling for all sizes. Flanges and couplings comply with ISO 5210 or MSS SP-102. Other base interfaces are available – apply to Rotork for details.

Thrust Bearings

Type 'A' and 'Z3' couplings include a fully sealed and lubricated-for-life thrust bearing. The thrust bases are designed to retain all the developed valve thrust reaction forces without any thrust load being transmitted to the actuator gearcase.

Drive Couplings

The removable drive bushes are supplied blank or pilot bored for machining to suit valve stem.

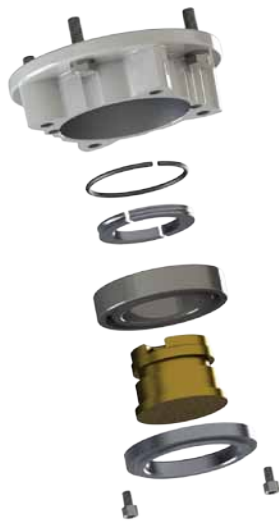

F10 Type A thrust base assembly.



F14 and F16 Type A thrust base assembly.



F25 and F30 Type A thrust base assembly.

IQ Actuator Drive Couplings

All size IQ actuators



Type A

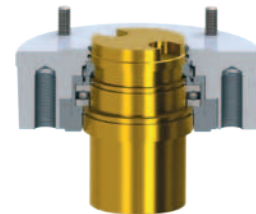

Type Z3

Increased reach

Thrust

Non-Thrust

Large fixed bore with ISO standard bore and keyway

Type B1

Fixed bore with ISO standard bore and keyway

Type B3

Blank drive bush for machining by customer

Type B4

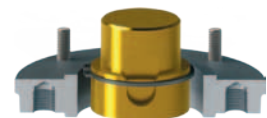
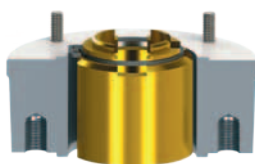

Standard Specifications

3 Introduction

IQ range actuators are self-contained, purpose designed and built for the local and remote electrical operation of valves. Comprising an electric motor, reduction gearing, reversing starter with local controls and indication, turns and torque limitation with electronic logic controls and monitoring facilities housed in a double-sealed watertight enclosure. Hazardous area certified enclosures meeting international and national requirements are also available.

All torque, turns settings and configuration of the indication contacts are made using the non-intrusive, handheld Rotork *Bluetooth®* Setting Tool Pro.

The specifications in this section cover IQ range standard and optional features. Enclosure requirements and selected build options must be specified at time of enquiry.

The actuator selection guideline on page 24 allows specifiers to identify suitable actuator types for particular valve and process applications, checking actuator type against other specification requirements.

The example enquiry datasheet below provides an outline of the basic information required for quotation. Where there is a project, framework or job specification applicable, Rotork will be pleased to analyse it in detail, in which case only valve details are required. The applicable actuator specification detail paragraph number is listed under the reference column for information.

It is not necessary to specify the actuator type, size or speed – Rotork will provide the most cost effective solution based on the information provided.

Page	Requirement	Options	Detail
24	Valve type	Part-turn	Ball/butterfly / plug – or other (specify)
		Multi-turn	gate/globe / penstock / sluice or other (specify)
25	Duty cycle	Isolating	Starts / hour
		Regulating	Starts / hour
		Modulating	Starts / hour
25	Operating time or turns	Sec	Turns
25	Seating Torque	Nm	lbf.ft
25	Running torque (if known)	Nm	lbf.ft
25	Thrust (multi-turn only)	kN	lbf
30	Power supply	1-phase	__Volts __Hz
		3-phase	__Volts __Hz
		DC	__Volts DC
30	Fail-safe	No	
		UPS	
27	Enclosure	Non-hazardous	IP / Nema rating
		Hazardous	Standard
31	Local Indication	Position display plus text display	Language required
33	Remote Control	Contacts	Actuator powered / Control system powered
		Analogue	4 to 20 mA other (specify)
		Digital bus-network	Type
34	Remote Indication	Volt free indication contacts	
		4 to 20 mA position indication	
		Digital bus-network	

Standard Specifications

4 Valve Type – Actuator Selection Guideline

Valve types are defined by the action required by the actuator for operation – multi-turn, part-turn or linear. The table below provides a guide to the actuators available and is determined by valve type, operating torque and duty requirement.

Actual selection may vary to those indicated below due to factors such as available power supply, mechanical interface, thrust requirements etc. Rotork will always offer the correct technical solution at the lowest cost for any application.

Valve Type	Duty*	Torque Min (Nm/lbsft)	Torque Max (Nm/lbf.ft)	Actuator Type	Comments
Multi-turn Gate valves	On-Off & Inching	13/10	3,000/2,200	IQ	General gate valves, penstock/sluiice, parallel slide, globe, choke
Multi-turn Gate valves	On-Off & Inching	100/135	43,000/32,000	IQ + IS or IB gearbox	General gate valves, penstock/sluiice, parallel slide, globe, choke
Multi-turn Low turns – non thrust	On-Off & Inching	1,000Nm		IQ + MTW gearbox	Non-thrust applications such as cable operated river gates
Multi-turn Control valve	Modulating	13/10	544/400	IQM	Control valves such as globe/cage/choke
Multi-turn Control valve	Modulating	400	21,000/15,500	IQM + IB/IS gearbox	Control valves such as globe/cage/choke
Part-turn	On-Off & Inching	1,000/740	500,000/370,000	IQ + IW gearbox	General 1/4 turn ball/butterfly/damper
Part-turn	Modulating	400	2,100	IQM + MOW gearbox	1/4 turn control valves ball, butterfly, damper
Linear	On-Off & Inching	Thrust 5.6 kN/1,260 lbf	Thrust 100 kN/22,400 lbf	IQL	General gate valves, globe, choke
Linear	Modulating	Thrust 6.3 kN/1,428 lbf	Thrust 60 kN/13,636 lbf	IQML	Control valves such as globe/choke/cage

Standard Specifications

5 Design Specification

The IQ range of actuators comply with standards
 EN 15714-2 Industrial Valves – Actuators – Part 2: Electric actuators for industrial valves – Basic requirements and ISA-SP96.02, Electric Actuators.

5.1 Duty Rating

Duty Classification	Actuator Type	Rating
On-Off & Inching	IQ / IQS / IQD	Nominal 60 starts per hour at a rate not exceeding 600 starts per hour. 15 minutes rated based on a nominal torque of 33% of rated (S2/S3, Class A & B)
Modulating	IQM / IQML	Nominal 1,200 starts per hour, 50% duty cycle based on a modulating torque of 50% of rated torque (S4, Class C)

5.2 Design Life

Design life is a function of actuator torque and speed. Values quoted are the minimum requirements; for most sizes/speeds life will be extended above the values quoted. Prior to life testing, actuators are stalled against a solid object 25 times to prove durability. Contact Rotork for more information.

Duty Classification	Actuator Type	Size	Minimum Design Life Rating
On-Off & Inching	IQ / IQS / IQD	10 - 35	Torque and thrust test: 10,000 cycles (500,000 output turns) seating at rated torque, 33% rated torque through stroke
		40 - 95	Torque and thrust test: 5,000 cycles (250,000 output turns) seating at rated torque, 33% rated torque through stroke
Modulating	IQM / IQML	12 - 35	1,800,000 starts at load of 50% rated torque (1 start constitutes at least 1° movement)

Standard Specifications

5.3 Vibration, Shock and Noise

Standard IQ range actuators are suitable for applications where vibration and shock severity does not exceed the following:

Type	Level
Plant induced vibration	1g RMS total for all vibration within the frequency range of 10 to 1,000 Hz
Shock	5g peak acceleration
Seismic	2g acceleration over a frequency range of 1 to 50 Hz if it is to operate during and after the event
Emitted noise	Independent tests have shown that at 1m generated noise does not exceed 70 db(A)

Levels quoted are those present at the actuator mounting interface. It should be noted that the effects of vibration are cumulative and therefore an actuator subjected to significant levels may have a reduced lifespan. Where excessive plant induced vibration is anticipated, mounting the actuator remote from the valve and driving via extension shafting (incorporating vibration absorbing couplings) may provide a satisfactory solution.

The IQ includes a vibration sensor that measures and captures vibration levels in the range 10 Hz to 1 kHz (RMS average) and peak acceleration (maximum g) in 3 axis (x, y and z). Vibration trend logs averaged over one hour can be viewed on the display or downloaded and viewed using Insight2.

5.4 Valve / Actuator Interface

The IQ range of actuators are available with mounting base and output drive couplings conforming to the following international standards:

Valve to actuator interface:

Valve type	Actuator Range	Area	Standard	Code
Multi-turn	IQ	International	ISO 5210	"F" metric
Multi-turn	IQ	USA	MSS SP-102	"FA" imperial
Part turn	IQ + 1/4 turn gearbox	International	ISO 5211	"F" metric
Part turn	IQ + 1/4 turn gearbox	USA	MSS SP-101	"FA" imperial

Applications for which the various types of couplings have been designed are outlined on page 22.

Actuator Orientation:

Actuators can be mounted in any orientation. The user/installer is responsible for considering the effects of orientation and subsequent loading on the supporting pipework and valve structure including any interface adaption kits.

Standard Specifications

5.5 Operating Temperature

Actuators are suitable for operation within the ambient temperature ranges shown below. Refer to Section 6 for Hazardous Area Certification operating temperature restrictions. For temperatures outside this range please contact Rotork. Prior to installation actuators should be stored in a dry location with a temperature range not exceeding -60 to 80 °C (-76 to 176 °F).

Actuator Type	Standard Temperature ¹	Low temperature option ¹
IQ, IQM, IQML	-30 to +70 °C (-22 to +158 °F)	Refer to Section 6
IQS, IQD	-20 to +70 °C (-4 to +158 °F) only	Not available

Note:

¹ Hazardous Area certification determines permissible operating temperature range. Refer to Section 6.

6 Non-Hazardous & Hazardous Certified Enclosures

All IQ actuator hazardous and non-hazardous area enclosures are watertight to IP68/NEMA Type 4 & 6. Through the use of non-intrusive commissioning and adjustment using the Rotork *Bluetooth*® Setting Tool Pro, covers never need removing and therefore the hermetic, factory-sealed enclosure protects internal components for life. The terminal compartment is sealed from other areas by the Rotork double seal, maintaining watertight integrity even during site connection.

In addition, the Rotork *Bluetooth*® Setting Tool Pro is certified Intrinsically Safe permitting power-on commissioning in hazardous areas.

Actuators are available with the following enclosure types for which the ambient working temperature ranges are stated. Where option temperatures are indicated, changes to some actuator components are required and therefore the temperature requirement must be specified. Hazardous area approvals for other country standards are available; please contact Rotork.

The IQ range of actuators are available built in accordance with the following standards:

6.1 Non-Hazardous Area Enclosures

WT: Standard Watertight

Standard	Rating	Standard temperature	Option 1	Option 2
IEC 60529 (1989-11)	IP66/IP68-7metres/72 Hrs	-30 to +70 °C	-40 to +70 °C	-50 to +40 °C
BS EN 60529 (1992)	IP66/IP68-7metres/72 Hrs	-30 to +70 °C	-40 to +70 °C	-50 to +40 °C
NEMA (US)	Type 4 & 6	-22 to +158 °F	-40 to +158 °F	-58 to +104 °F
CSA (Canadian)	Type 4 & 4X	-22 to +158 °F	-40 to +158 °F	-58 to +104 °F

Standard Specifications

6.2 Hazardous Area Enclosures

European Hazardous Area Directive – ATEX

Directive Code	Enclosure Code	Standard Temperature	Temperature Option 1	Temperature Option 2	Temperature Option 3
ATEX II 2GD c	Ex d IIB T4 Ex d IIC T4 Ex tb IIIC T120°C T4	-20 to +70 °C (-4 to +158 °F)	-30 to +70 °C (-22 to +158 °F)	-40 to +70 °C (-40 to +158 °F)	-50 to +40 °C (-58 to +104 °F)
	Ex de IIB T4 Ex de IIC T4 Ex tb IIIC T120°C T4	-20 to +70 °C (-4 to +158 °F)	-30 to +70 °C (-22 to +158 °F)	-40 to +70 °C (-40 to +158 °F)	-50 to +40 °C (-58 to +104 °F)

International Hazardous Area – IECEx

Enclosure Code	Standard Temperature	Temperature Option 1	Temperature Option 2	Temperature Option 3
Ex d IIB T4 Ex d IIC T4 Ex tb IIIC T120°C T4	-20 to +70 °C (-4 to +158 °F)	-30 to +70 °C (-22 to +158 °F)	-40 to +70 °C (-40 to +158 °F)	-50 to +40 °C (-58 to +104 °F)
Ex de IIB T4 Ex de IIC T4 Ex tb IIIC T120°C T4	-20 to +70 °C (-4 to +158 °F)	-30 to +70 °C (-22 to +158 °F)	-40 to +70 °C (-40 to +158 °F)	-50 to +40 °C (-58 to +104 °F)

USA Hazardous Area – Factory Mutual Certified Explosionproof to FM3615

Class	Division	Groups	Standard Temperature	Temperature Option 1	Temperature Option 2
I II	1	C, D, E, F, G	-22 to +158 °F (-30 to +70 °C)	-40 to +158 °F (-40 to +70 °C)	-58 to +104 °F (-50 to +40 °C)
		B, C, D, E, F, G	-22 to +158 °F (-30 to +70 °C)	-40 to +158 °F (-40 to +70 °C)	-58 to +104 °F (-50 to +40 °C)

Canadian Hazardous Area – Canadian Standards Association (CSA EP) to C22.2 No 30-M

Class	Division	Groups	Standard Temperature	Temperature Option 1	Temperature Option 2
I II	1	C, D, E, F, G	-22 to +158 °F (-30 to +70 °C)	-40 to +158 °F (-40 to +70 °C)	-58 to +104 °F (-50 to +40 °C)
		B, C, D, E, F, G	-22 to +158 °F (-30 to +70 °C)	-40 to +158 °F (-40 to +70 °C)	-58 to +104 °F (-50 to +40 °C)

Standard Specifications

Rotork *Bluetooth*[®] Setting Tool Pro Certification

Directive / Standard	Rating	Standard Temperature
ATEX II 1G	Ex ia IIC T4	-30 to +50 °C (-22 to +122 °F)
FM3610	Intrinsically Safe Class I, Div 1 groups A,B,C,D: T4	-30 to +50 °C (-22 to +122 °F)
Canada CSA – C22.2 No.157-92	Exia - Intrinsically Safe Class I, Div 1 groups A,B,C,D: T4	-30 to +50 °C (-22 to +122 °F)

7 Regulatory Standards

Compliance with the following European Economic Community Directives permits IQ range actuators to be CE marked under the provision of the Machinery Directive.

Directive	Applicable to	Reference
Electromagnetic compatibility (EMC)	Immunity to/emissions of electromagnetic energy	2004/108/EC
Low voltage (LV)	Electrical safety	2006/95/EC
Machinery ¹	Product safety	Actuators follow the provision of the Machinery Directive 2006/42/EC. The IQ must not be put into service until the equipment into which it is being incorporated has been declared to be in conformity with the provisions of the European Community Machinery Directive 2006/42/EC.
Waste Electrical Equipment (WEE)	Exempt under the scope of the directive	
Federal Communications Commission	<i>Bluetooth</i> modules - actuator and Rotork <i>Bluetooth</i> [®] Setting Tool Pro.	Contains FCC certified transmitter module. Refer to PUB002-039 for FCC ID.

Note:

- 1 Actuators are not classified as machines within the scope of the machinery directive. Contact Rotork for a copy of our Declaration of Conformity and Incorporation.

Standard Specifications

8 Power, Control & Indication

8.1 Power Supplies

IQ actuators are suitable for operation with the following single- and three-phase three wire and DC power supplies:

Supply voltage ranges – Actuator availability

Standard Voltages	Phase	IQ10 to IQ70 & IQ95	IQ90 & IQ91	IQM IQML	IQS	IQD10	IQD12 IQD18	IQD20 IQD25
24	DC	X	X	X	X	✓	X	X
48	DC	X	X	X	X	✓	✓	X
110	DC	X	X	X	X	✓	✓	✓
100,110,115,120	1	X	X	X	✓	X	X	X
208,220,230,240	1	X	X	X	✓	X	X	X
200,208,220,230,240	3	✓	X**	✓**	X	X	X	X
380,400,415,440,460,480	3	✓	✓**	✓	X	X	X	X
500,550,575,590	3	✓	✓	X	X	X	X	X
600,660,690	3	✓	✓	X	X	X	X	X

Voltage tolerance	+/-10%	Applies for rated torque performance; duty cycle and speed is not guaranteed
Frequency tolerance	+/-5%	Applies for rated torque performance; duty cycle and speed is not guaranteed
Max. starting volt drop	-15%	Actuators capable of starting and running up to speed
Non standard tolerances	Larger volt drops / frequency variations than those quoted can be catered for but may affect actuator selection / sizing. Contact Rotork.	
Uninterruptible power supply systems	For AC systems, UPS systems should conform to recognised supply standards such as EN60160 in respect of waveform, spikes, harmonics etc. The tolerances above should not be exceeded.	

** Limited availability

IQ91 not available at 380 V 60 Hz. IQ90 has limited availability at voltages up to 240 V.

IQM/IQML35 not available at voltages below 380 V.

Reference documents

For operating electrical consumption data refer to PUB002-018 (IQ ranges) and PUB002-032 (IQM ranges) available to download at www.rotork.com

Standard Specifications

8.2 Local Control, Indication & Set-up

Non-intrusive selectors are provided on the actuator electrical control cover which also includes a window showing actuator position, status and alarm display.

The control cover may be rotated through 360° (90° increments) to suit actuator orientation/operator access. Set-up is over a *Bluetooth* interface using the supplied Rotork *Bluetooth*® Setting Tool Pro.

Standard local controls

Operation	Type	Function	Comments
Control mode	Red, rotary selector	Selects "Local", "Stop" or "Remote" control	Can be padlocked in each position (stop remains available) for site operational protection
Local control	Black, rotary selector	Initiates local "Open" and "Close" operation	Spring return to centre neutral position. Local control may be user configured for inching action
<i>Bluetooth</i>	Rotork <i>Bluetooth</i> ® Setting Tool Pro	Initiates local "Open" and "Close" operation	May be user configured for <i>Bluetooth</i> operation over a nominal distance of 10 m (30 feet)

Standard local indication

Operation	Type	Function	Comments
Position indication	LCD - Large character (25 mm/1")	Close icon – 0-99% (0.1% increments) – Open Icon	Back-lit (power on) – operating temperature range -50 to +70 °C (-58 to +158 °F). Battery supported power off
Position indication	Coloured indication lights	Green (close), Red (open) Yellow (mid-travel)	Power on – lamp indication, colours can be reversed. Blinker and alarms can be configured to indicate
Status and Alarm (multi language)	LCD – position display status and alarm text	Real time status and alarm text integrated into position display	Power on – battery supported (when awake)
Status and Alarm (multi language)	LCD – text display	Real time status and alarm text via status	Power on – battery supported (when awake)
Status and Alarm (multi language)	General alarm Battery alarm	Display icons	At a glance indication, detail provided by status/alarm text

Standard Specifications

8.2 Local Control, Indication & Set-up cont.

Actuator Set-Up, Configuration & Datalogging

Setting Tool & LCD displays

Simple non-intrusive, interactive set-up procedure using supplied Rotork *Bluetooth*® Setting Tool Pro with read-back from LCD's. Settings include limits & torque, indication contacts and control options. Settings may be password protected. Setting tools are provided on a 1 for 10 actuators basis.

PC/PDA

Using freeware Insight2, actuators may be configured / analysed over *Bluetooth* interface.

Datalogging

Standard onboard datalogger provides valve torque and starts profiles, operational statistics, events log. Actuator configuration & manufacturing data also available. Files can be downloaded direct to PC or to Rotork *Bluetooth*® Setting Tool Pro (IS certified) for transport to office PC. Freeware Insight2 for PC is available to download at www.rotork.com

Options

Vandal resistant

Option 1:
Red/black control selectors not fitted

Option 2:
Red/black control selectors not fitted + lockable window cover

Option 3:
Stainless steel lockable cover protects standard selectors and window

Reference documents

Refer to PUB002-039 for details of status and alarm text messages, alarm icons, help screens and actuator set up procedure.

Refer to PUB095-001 for Rotork *Bluetooth*® Setting Tool Pro manual.



Standard Specifications

8.3 Remote Control & Indication

IQ range actuators enable remote control and indication of valves for centralised control. Actuator control and indication forms are available to meet the requirements of the various site control systems, from simple manual push-button control through to sophisticated Distributed Control Systems (DCS) using relay outputs or digital “bus” network systems.

Standard remote controls

Operation	Type	Range	Comments
Open/Close/Maintain Common	Positive switched 3 x opto-isolated inputs designed for fleeting or maintained contacts	20 - 60 VDC, 40 - 120 VAC	Actuator derived 24 VDC (120 VAC available as an option) or externally supplied derived from the control system. Various forms available.
ESD Open interlock Close interlock Common	Positive switched 3 x opto-isolated inputs designed for maintained contacts.	20 - 60 VDC, 40 - 120 VAC	ESD can be user configured open, stayput or close, from an NO or NC contact. ESD has priority over all other applied local or remote control signals. Interlocks provide hardwired “permissive” protection (ie. main and bypass control) and are active for local and remote or may be configured for remote signals only.
Drive enable (option)	Positive switched 1x opto-isolated input. (maintain input)	20 - 60 VDC, 40 - 120 VAC	Maintain input configurable as drive enable: actuator will not operate unless signal is applied.

Options

120 VAC actuator derived supply	5 VA rated	Actuator derived supply for remote control.
125 VDC remote control	20 mA per input	Suitable for 125 VDC remote control supply - positive switching.
Negative switching	20 - 60 VDC	Suitable for negative switched systems applies to open, stop, close, ESD and interlocks.
Analogue control – Option Folomatic	0 to 5/10/20 mA or volt ranges	Proportional control over the whole or part of valve stroke. Configurable for open, close or stayput on loss of analogue signal.
Hydraulic shock ‘water hammer’/surge protection – Option Interrupter timer	Internal control system - Interrupter timer	Pulsed operation with independently adjustable on and off time periods in the range 1 - 99 seconds can be selected to operate over any portion of the closing or opening valve stroke, effectively reducing valve speed.

Standard Specifications

8.3 Remote Control & Indication cont.

Standard remote indication

Operation	Type	Range	Comments
Position, status and alarm indication	4 x configurable volt free latching contacts - S1 to S4. Single pole -single throw (SPST), configurable NO or NC	5 mA to 5 A ¹ , 120 VAC, 30 VDC	Independently configurable using the supplied Rotork <i>Bluetooth</i> ® Setting Tool Pro to signal one of the following: Valve position: fully open, fully closed or intermediate positions (0-99% open) Status: Valve opening, closing, moving, local stop selected, local selected, remote selected, open or close interlock active, ESD active Valve alarms: Torque tripped in mid travel, going open, going closed, valve jammed, handwheel operation Actuator alarms: Lost phase (3-phase IQ only), customer 24 VDC (120 VAC) supply lost, battery low, internal failure detected, thermostat tripped, service alarms (refer to page 6)
Actuator availability / fault	Monitor relay configurable change over contact	5 mA to 5 A, 120 VAC, 30 VDC	In available mode the relay will de-energise when the actuator is unavailable for remote control due to any one or more of the following conditions: Power supply or control supply lost; local control selected; local stop selected; motor thermostat tripped; detected internal failure In fault mode, as above but ignores local/stop selection

Options

Operation	Type	Range	Comments
Position, status and alarm indication	Up to 8 configurable volt free latching contacts. Single pole – change over (SPCO)	5 mA to 5 A ¹ , 120 VAC, 30 VDC	Independently configurable using the supplied Rotork <i>Bluetooth</i> ® Setting Tool Pro as per contacts S1 to S4 above
Analogue position feedback	Current position transmitter - CPT	4 to 20 mA output proportional to position	Auto range to set limits. Normally internally powered, available suitable for externally 'loop' powered - will default to 4 mA when actuator is powered down.
Analogue torque feedback	Current torque transmitter - CTT	4 to 20 mA output proportional to output torque	Range 0% to 120% of rated torque (4 to 20 mA)
Auxilliary power supply	Maintains power to the actuator control on loss of mains	Nominal 24 VDC, 1 A (switching inrush 8 A max)	Customer supply maintains backlit display, CPT analogue indication and bus network communications during actuator power outages. Customer supply is isolated from internal control power for protection

Reference documents:

Refer to PUB002-041 IQ Control and Monitoring.

Note:

1 Maximum total combined current through all four relays not to exceed 8 A.

Standard Specifications

8.4 Fieldbus System Control Options

IQ range actuators are available with the following network interface cards to enable remote control and indication using digital “bus” network systems communication to the Distributed Control Systems (DCS).

Standard remote controls

Network Type	Comments
Pakscan	An internally mounted Pakscan field unit for remote control and status indication over a fault tolerant two wire serial link. Loop distances of up to 20 km without repeaters and host communications using Modbus protocol. System variables programmable over the <i>Bluetooth</i> data link. For more information please refer to PUB059-030.
Modbus	Modbus modules suitable for single or dual communication highways may be included in the IQ actuator, to provide Fieldbus communication of all the actuator control functions and feedback data. Data is carried on an RS485 data highway and the communications protocol used is Modbus RTU. System variables such as unit address and data baud rate are programmed over the <i>Bluetooth</i> data link. For more information please refer to PUB091-001.
Profibus	A Profibus DP interface module is available to allow the actuator to be integrated into a Profibus network. Full compatibility with EN 50170 is provided and the Profibus network allows full actuator control and feedback of data to the host. For more information please refer to PUB088-001.
Foundation Fieldbus	An IEC 61158-2 compliant Foundation interface module allows the actuator to be connected to a Foundation network. The device has link scheduler capability as well as digital and analogue function block capability. Foundation Fieldbus actuators can communicate directly between themselves without the need of a host supervisory system. For more information please refer to PUB089-001.
HART	HART (Highway Addressable Remote Transducer) is a process control communication protocol. The signal consists of two parts, the analogue 4 to 20 mA current loop and a superimposed digital signal. Traditionally the 4 to 20 mA loop is used for control and the superimposed digital signal for feedback, diagnostics and configuration. Configuration and feedback using the HART digital signal can be achieved using the host connected to the actuator to select the parameters required. The majority of the user configurable settings can be made over the HART communication protocol. See PUB092-001 for further details.



Standard Specifications

9 Protection & Operating Features

The IQ control system incorporates the following standard operating features and comprehensive valve, actuator and control protection to ensure reliable valve operation and protection under all circumstances.

Fault / Feature	Cause / Operation	Function
Obstructed valve	Valve meets an obstruction or process conditions that prevent movement. Obstruction must be sensed and operation prevented to prevent damage to valve and actuator.	Independent Settable Open and Close Torque Switches Torque switch will "torque trip" the actuator motor when the preset output torque level is reached. Torque switches can be set in the range 40% to 100% of rated torque. Torque trips are indicated on the actuator display and can be remotely signalled.
Jammed valve	Valve is stuck in its seat at the close or open position and operation fails to move the actuator and clear the limit position.	Jammed valve protection Torque switch will "torque trip" the actuator motor when the preset output torque level is reached or at 150% (nominal) if set to "bypass torque switch". Torque switches can be set in the range 40% to 100% of rated torque. Jammed valve protection prevents damage to valve and is indicated on the actuator display or remotely signalled.
Torque switch bypass	Provides increased torque above actuator rated for unseating sticky valves.	Torque Switch By-pass User selectable, torque switches are automatically bypassed during the first 5% of travel from both open and close limit positions. This permits torque above actuator rated torque and up to actuator stall torque (1.4 to 2.4 times rated torque) to be developed during unseating, ensuring "sticky" valves do not cause unwanted torque trips. Refer also to jammed valve protection, above.
Torque switch hammer	Actuator repeatedly tries to move an obstructed valve in response to a standing control signal. This can cause damage to both valve and actuator.	Anti Hammer Protection Once a torque trip occurs the control prevents repeated operation in the same direction as a response to a standing remote or local control signal. Actuator must be operated in the opposite direction and therefore moved away from the obstruction, which then has a chance to clear, before it can be signalled to run in the requested direction. Torque trips are indicated on the actuator display and can be remotely signalled.
Incorrect phase rotation (3-phase actuators only)	Due to 3-phase supply wiring incorrectly connected to actuator. Actuator moves in the opposite direction to that signalled. At end of travel the wrong limit/torque switch is activated preventing the motor being de-energised and causing it to stall with consequent valve damage and/or motor burn-out.	Syncrophase™ Protection ensures actuator always runs in the correct direction corresponding to the applied control signal (open or close). The patented circuit senses connected phase rotation and ensures the actuator always runs in the correct direction by energising the appropriate motor control contactors/switches.
Lost phase / motor overheating (3-phase actuators only)	"Single phasing". One of the 3 phases applied to the actuator is lost due to fault causing the motor to single phase i.e. attempts to run with only 2 of the 3 phases applied. Motor may fail to start (stall) or run unbalanced causing overheating and possible burn-out.	Syncrophase™ The patented circuit monitors all three supply phases. If a phase is lost the Syncrophase circuit prevents the motor from being energised. If during operation one phase is lost this cannot be detected due to back-feed through the motor windings, however once operation stops, re-energising of the motor will be prevented. Lost phase is indicated on the actuator display and can be remotely signalled.
Motor overheating	Actuator duty cycle is exceeded causing the motor to overheat. This often occurs during factory acceptance testing /commissioning or during process start up.	Motor Thermostat Protection Two thermostats are embedded in the motor end windings (hottest part of the motor) which directly sense motor temperature. Thermostats will open circuit when set temperature is reached causing the motor to be de-energised. Thermostats will auto-reset once the motor has cooled sufficiently allowing operation to continue. Motor thermostat trips are indicated on the actuator display and can be remotely signalled.

Standard Specifications

9 Protection & Operating Features cont.

Fault / Feature	Cause / Operation	Function
Instantaneous reversal	Control system instantaneously reverses the control signal which causes the actuator to reverse direction with associated inertial stress to valve drive and internal motor switching surges.	Instantaneous Reversal Protection A delay of 300 ms is automatically applied between reversals allowing the actuator to come to rest before responding to reverse control signal.
Actuator fault	Detected actuator fault.	ASTD (automatic self test & diagnosis) ASTD detects any internal control system failures preventing operation. Detected internal control system faults are indicated on the actuator display allowing rapid diagnosis and can be remotely signalled. In addition diagnostic screens can be accessed allowing problem to be pin-pointed.
Remote control circuit failure (actuator derived remote control supply only)	Loss of remote control.	Remote Control Supply The 24 VDC internal power supply made available for remote control switching is protected by an auto-reset fuse device. Should the power drawn from the supply exceed its rating (due to a remote control wiring fault, etc.), the fuse will disconnect the supply. Once the fault is cleared the supply will automatically be reinstated. Loss of internal supply is indicated on the actuator display and can be remotely signalled.
Spurious operation	Operation commanded due to unintended or spurious remote control signals leading to process problems or hazards.	Conditional Control User selectable. The interlock input can be configured for "conditional control", being active only for remote control. In this mode, for the actuator to respond to a remote control signal, two signals must be applied simultaneously, one to the control input and one to the interlock input. If an unintended or spurious signal is applied only to the control input it will be ignored. Intended signals can therefore be verified by applying a second "permissive" signal, effectively preventing spurious operation.
Emergency Shutdown (ESD)	Priority action where the valve is required to stayput or move to a safe end-of-travel position determined by the process - open or closed limit.	Dedicated ESD Control Input User configurable, the ESD action has priority over any existing or applied local or remote control signal. ESD can be configured to open, close or stayput depending on the process requirements. ESD must be derived from a latched type, normally open or normally close ESD contact (configurable) and may be configured to override local stop, interlocks or interrupter timer.



Standard Specifications

10 Components

Details of major actuator mechanical and electrical/electronic components are provided below:

10.1 Handwheel

A handwheel is provided to allow manual operation of the valve during electrical power interruption. Handwheel size and mechanical advantage are generally designed in accordance with standards EN 12570 and AWWA C540 (American Water Works Association) to give the most efficient compromise of force and turns for emergency operation.

Handwheel turns:

Actuator size	Standard Type / Ratio	Option
IQ10, IQ12, IQ18	Direct / 1:1	Geared / 5:1
IQ20	Direct / 1:1	Geared / 13.3:1
IQ25	Geared / 13.3:1	Direct / 1:1 ¹
IQ35	Geared / 22.25:1	X
IQ40	Geared / 15:1	Geared / 30:1
IQ70, IQ90, IQ91	Geared / 30:1	Geared / 45:1
IQ95	Geared / 45:1	Geared / 30:1 ¹

Note:

- 1 Rimpull does not meet the requirements of EN12570 at actuator rated torque. May be used for lower torque applications or where higher handwheel forces are acceptable.

During electric operation of the actuator, the handwheel is mechanically disengaged from the drive. To engage handwheel operation, the hand/auto selection lever is pushed down and released after which handwheel operation remains selected. When electrical operation takes place the actuator will automatically return to motor drive without lever or handwheel kickback.

The hand/auto selection lever incorporates a facility for locking in the hand or auto positions using a 6 mm diameter hasp padlock (not supplied by Rotork), preventing engagement of motor drive (locked in hand) or engagement of handwheel drive (locked in auto). Emergency disengagement of motor drive can be selected by pushing down and holding the hand/auto lever during electric operation.

Standard Specifications

10.2 Lubrication

IQ actuators are factory filled for life with premium quality gear oil selected for the application. Standard oils are automotive grades easily available worldwide and have been used successfully for over 40 years. Oil lubrication out-performs grease over a wide temperature range and allows installation in any orientation. It has none of the problems associated with grease such as separation at elevated temperatures and “tunnelling” at lower temperatures where grease is thrown away from rotating components creating a void or tunnel in the grease around components that require lubrication.

Lubrication

Range	Standard temperature range -30 to +70 °C (-22 to +158 °F)	Option low temperature -50 to +40 °C (-58 to +104 °F)	Option food grade -10 to +70 °C (-14 to +158 °F)
IQ	SAE80EP	MOBIL SHC624	Hydra Lube GB Heavy

Food grade

Lubricant is a synthetic, non-aromatic hydrocarbon mixture with PTFE and other additives. It does not contain chlorinated solvents. Food grade grease used in assembly and thrust bearings is Hydra Lube WIG Medium-NLGI-123.

10.3 Finish

All IQ actuator finishes are tested in accordance with Rotork 1,000 hour cyclic salt spray test procedure which is the most realistic and arduous test cycle applicable. The test combines cyclic salt spray, drying and humidity at elevated temperatures on complete factory built actuators. This tests the finish and the various substrate materials, fixings and interfaces that make up an actuator. Substrate materials and finishes are selected to provide maximum corrosion resistance combined with good adhesion.

For full specification of paint finishes refer to PUB000-046.

Finish

Range	Size	Standard finish	Offshore finish
IQ	All sizes	Polyester powder coating, silver grey	2 pack epoxy coatings

Project specific finishes / colours can be catered for. Apply to Rotork.

Standard Specifications

10.4 Motor

IQ actuators utilise purpose designed motors that are integral to the actuator. As such, these motors do not fall within the scope of IEC 60034 or MG1, however they do meet the

applicable requirements, where appropriate, of motor design for actuator operation.

Actuator Type	Duty Classification	Comments
IQ	On-Off & Inching (Class A & B)	Class F insulated, 3-phase squirrel cage motor incorporating thermostat protection. Low inertia design. Nominal 60 starts per hour at a rate not exceeding 200 starts per hour, 15 minutes rated based on a nominal torque of 33% of rated. Class H available as an option where hazardous area certification does not limit temperature rise to "T4" 135 °C.
IQS	On-Off & Inching (Class A & B)	Class F insulated, single phase capacitor / run start squirrel cage motor incorporating thermostat protection. Low inertia design. Nominal 60 starts at a rate not exceeding 200 starts per hour per hour, 15 minutes rated based on a nominal torque of 33% of rated. Class H available as an option where hazardous area certification does not limit temperature rise to "T4" 135 °C.
IQD	On-Off & Inching (Class A & B)	Class F insulated, permanent DC brush motor incorporating permanent magnet DC brush motor incorporating thermostat protection. Nominal 60 starts per hour at a rate not exceeding 200 starts per hour, 15 minutes rated based on a nominal torque of 33% of rated.
IQM	Modulating (Class C)	Class F insulated, 3-phase squirrel cage motor incorporating thermostat protection. User selectable thyristor controlled dynamic braking available. Low inertia design. 1,200 starts per hour, 50% duty cycled based on a modulating torque of 50% of rated torque. Class H available as an option where hazardous area certification does not limit temperature rise to "T4" 135 °C.

Reference documents

IQ / IQS / IQD Motor data publication PUB002-018. IQM / Motor data publication PUB002-032.



Standard Specifications

10.5 Power Module

The power module for IQ actuators produces internal power supplies for control systems and remote control derived from the actuator electrical supply. It also contains the motor control and switching components.

Actuator Type	Internal power supplies	Motor switching
IQ	Split bobbin transformer producing control circuits, option card supplies and supply for 24 VDC actuator fed remote control (120 VAC option).	Reversing contactor assembly, mechanically and electrically interlocked. 24 VDC coil up to and including size IQ35 and 120 VAC for IQ40 and above.
IQD	DC-DC converter isolates the DC actuator supply from internal supplies for control and 24 VDC supply for actuator fed remote control. Fuse protected. Incorporates sleep circuit for power reduction when used on solar powered derived DC supplies.	Reversing contactor assembly, mechanically and electrically interlocked.
IQS	Split bobbin transformer producing control circuits, option card supplies and supply for 24 VDC actuator fed remote control (120 VAC option). Fuse protected.	Solid state thyristor array for motor switching / reversal and capacitor starting. Includes snubber protection and timing control.
IQM	Split bobbin transformer producing control circuits, option card supplies and supply for 24 VDC actuator fed remote control. Fuse protected.	Solid state thyristor array for motor switching / reversal and braking (user selectable). Includes snubber protection and timing control.

10.6 Torque Sensor

State of the art piezo thrust sensor measures motor shaft thrust produced as a reaction to output torque developed in the motor worm and wheel gear assembly. Thrust measured is directly proportional to output torque. The piezo sensor develops a voltage proportional to shaft thrust (output torque) which is amplified and then measured by the control module. Output torque is controlled by switching the motor off when the set torque limits have been reached. This system allows the torque to be displayed via the LCD display and captured by the datalogger in the form of valve torque profiles, statistical torque information and the event log.

10.7 Position Sensor

Using the latest technology and after years of testing, the patented Rotork IQ absolute encoder is contactless, has only four active parts, can measure up to 8,000 output turns with a resolution of 7.5° and has redundancy and self checking. Unlike existing absolute encoder designs, this technological breakthrough increases position sensing reliability while providing zero-power position measurement.

Standard Specifications

10.8 Control and User Interface (UI) Modules

The control and UI modules for IQ actuators are common and take the form of a PCB with on-board liquid crystal displays (LCD) and a control PCB. For IQM actuators the control module incorporates “fast remote” mode (24 VDC remote control only) allowing rapid actuator switching down to 100 ms pulses for precise positioning.

Logic controlled, the control module is programmed over the non-intrusive *Bluetooth* interface with set-up configuration for torque, limits indication and control features undertaken using the Rotork *Bluetooth*® Setting Tool Pro. It monitors local and remote control signals, torque and position to switch the actuator motor in the correct direction or off.

Standard IQ control features are shown below:

Feature	Type	Specification
Remote control	Input	User switched Open/Close/Stop/ESD and interlock signals. Opto-isolated inputs for protection.
Local control	Input	Open/Close/Stop and Local/Remote selection. Non-intrusive control switches are magnetically operated so there is no penetration of covers.
Position	Input	Digital signal derived by absolute position sensor. Resolution to 7.5° of output rotation. Limit range configurable between 2.5 and 8,000 output turns.
Torque	Input	The piezo thrust sensor directly measures output torque and converts value to a voltage signal. Torque can be set in the range 40% to 100% of rated torque with the additional facility to bypass torque switching.
Set-up	Input	Set-up over the <i>Bluetooth</i> interface allows all settings to be configured for valve and process requirements. Set-up is non-intrusive requiring no covers be removed using the supplied Rotork <i>Bluetooth</i> ® Setting Tool Pro. All settings can be password protected.
Indication contacts	Output	Four Volt free contacts S1 to S4 can be configured for a variety of position, status and alarm indication for remote indication and monitoring.
LCD indication	Output	The onboard backlit LCD display presents position, torque and setup displays for configuration. The LCD display is divided into 2 parts providing a large position indication (Open/Close icons plus % readout in 0.1% increments for mid travel) and a multilingual text display providing status, alarm and set up information.
Datalogger	Output	The control module includes a datalogger which stores torque, position and operational data in non-volatile memory for download via <i>Bluetooth</i> to the supplied Rotork <i>Bluetooth</i> ® Setting Tool Pro or notebook PC. Data is date/time stamped. Datalogger can be analysed using freeware Insight2 for PC.
Memory	System	All configured settings are stored in non-volatile EEPROM memory (does not require power).
Micro-controller	System	Provides all control function logic, setup programming and allied system requirements. Software is field upgradeable for future enhancements. The micro-controller is widely used in the automotive industry with a long track record and a very reliable history.

Standard Specifications

10.9 Conduit / Cable Entries

IQ gearcases are machined with conduit/cable entries as indicated below. Alternative adapters are available.

Number of entries required and adapter type must be specified with order.

Actuator type	Gearcase entries	Adapter 1	Adapter 2
IQ Standard	2 x M25 plus 1 x M40	2 x 1" plus 1 x 1.5" ASA NPT	2 x PG16 plus 1 x PG29
IQ Option	Additional 1 x M25	Additional 1 x 1" ASA NPT	1 x PG16

IQ actuators are despatched with transit plugs fitted into the conduit entries. It is the responsibility of the installer to ensure the appropriate cable/conduit adapters, cable glands and/or blanking plugs are fitted in order to maintain hazardous area certification and ingress protection levels. Certified adapters and blanking plugs are available as optional extras.

10.10 Terminals

The terminal compartment for IQ actuators takes the form of a separately sealed compartment containing segregated metric thread M5 power and M4 control terminals. Terminal screws and washers are supplied with the actuator. Terminals are designed to accept ring tag crimped field wiring conductors up to 16 mm² for power and 4 mm² for control/indication. The terminal compartment cover carries a terminal identification code card. Each actuator is despatched with the applicable Installation and Maintenance Manual, actuator wiring diagram and remote control connection schematic.

10.11 Wiring

IQ actuators utilise jig built wiring harnesses of individually numbered, tropical grade PVC insulated, stranded conductors. All internal control connections to the printed circuit boards use unique or polarised plugs and sockets.

10.12 Battery

The battery provides power to support the LCD display and remote (relay) indication when the main actuator supply is unavailable. The battery also provides power to enable actuator settings to be made using the Rotork *Bluetooth*[®] Setting Tool Pro; commissioning can take place at premises without power or the right voltage, or after installation but before site cabling is completed.

The standard 9 V battery is available worldwide with a high/low temperature type available from Rotork.

As all settings are stored in non-volatile memory and position is sensed by the Rotork absolute encoder, security of configuration and position is always assured. The actuator can be operated perfectly well electrically and by handwheel operation without a battery fitted.

Based on experience gained over 20 years of typical applications, the expected battery life is up to five years.

Battery life is however subject to temperature and at elevated and reduced temperatures may be reduced. Actuator indicates battery status locally and in remote.

rotork®

Redefining Flow Control

www.rotork.com

A full listing of our worldwide sales and service network is available on our website.

Rotork plc
Brassmill Lane, Bath, UK
tel +44 (0)1225 733200
fax +44 (0)1225 333467
email mail@rotork.com

Scan with your smart phone
for more information on
this product range



PUB002-038-00
Issue 11/12

As part of a process of on-going product development, Rotork reserves the right to amend and change specifications without prior notice. Published data may be subject to change. For the very latest version release, visit our website at www.rotork.com

The name Rotork is a registered trademark. Rotork recognises all registered trademarks. The Bluetooth® word mark and logos are registered trademarks owned by Bluetooth SIG, Inc. and any use of such marks by Rotork is under license. Published and produced in the UK by Rotork Controls Limited. POWTG1112